

TB150ADJ

T BLADE STIRRUP, HEAVY DUTY, ADJUSTABLE

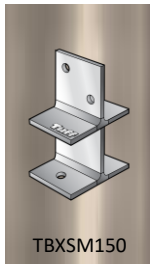
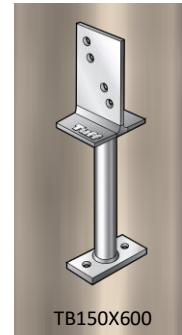
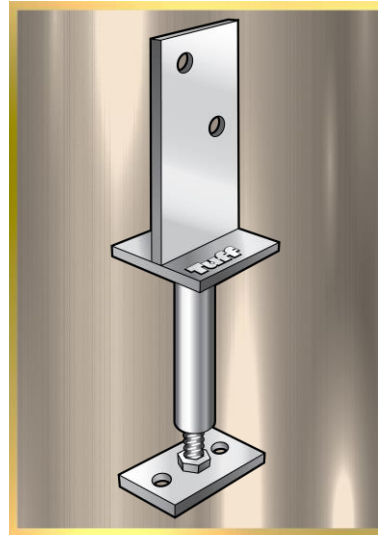
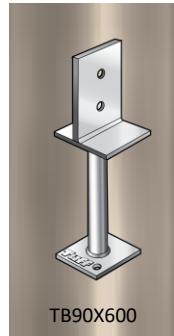

PRODUCT CODE	: TB150ADJ
BARCODE	: 9314691808342
BLADE SIZE	: 130MM X 250MM
SHAFT HEIGHT	: 270MM-470MM
SHAFT Ø	: 48MM
POST BOLT HOLE	: M24
MADE FROM	: 10MM
FINISHING	: HOT DIP GALVANISED

NOTES:

- IDEAL FOR PERGOLA, CARPORT AND VERANDA POSTS
- PRIMARILY USED FOR BOLTING TO EXISTING TIMBER DECKING OR CONCRETE BASE
- SUITS 150MM TIMBER POST
- USED TO ADJUST HEIGHT OF T-BLADE TO SUIT VARIATION IN FLOORING LEVEL